

FCC Information and Copyright

This equipment has been tested and found to comply with the limits of a Class B digital device, pursuant to Part 15 of the FCC Rules. These limits are designed to provide reasonable protection against harmful interference in a residential installation. This equipment generates, uses, and can radiate radio frequency energy and, if not installed and used in accordance with the instructions, may cause harmful interference to radio communications. There is no guarantee that interference will not occur in a particular installation.

The vendor makes no representations or warranties with respect to the contents here and specially disclaims any implied warranties of merchantability or fitness for any purpose. Further the vendor reserves the right to revise this publication and to make changes to the contents here without obligation to notify any party beforehand.

Duplication of this publication, in part or in whole, is not allowed without first obtaining the vendor's approval in writing.

The content of this user's manual is subject to be changed without notice and we will not be responsible for any mistakes found in this user's manual. All the brand and product names are trademarks of their respective companies.



Dichiarazione di conformità sintetica

Ai sensi dell'art. 2 comma 3 del D.M. 275 del 30/10/2002

Si dichiara che questo prodotto è conforme alle normative vigenti e soddisfa i requisiti essenziali richiesti dalle direttive

2004/108/CE, 2006/95/CE e 1999/05/CE

quando ad esso applicabili

Short Declaration of conformity

We declare this product is complying with the laws in force and meeting all the essential requirements as specified by the directives

2004/108/CE, 2006/95/CE and 1999/05/CE

whenever these laws may be applied

Table of Contents

Chapter 1: Introduction	1
1.1 Before You Start.....	1
1.2 Package Checklist.....	1
1.3 Motherboard Features.....	2
1.4 Rear Panel Connectors.....	3
1.5 Motherboard Layout	4
Chapter 2: Hardware Installation	5
2.1 Installing Central Processing Unit (CPU)	5
2.2 Install a Heatsink	6
2.3 Fan Headers.....	7
2.4 Installing System Memory	8
2.5 Connectors and Slots.....	10
Chapter 3: Headers & Jumpers Setup	12
3.1 How to Setup Jumpers	12
3.2 Detail Settings	13
Chapter 4: AMD DUAL Graphics Technology	17
4.1 AMD Dual Graphics Technology Introduction.....	17
4.2 AMD Dual Graphics Requirement.....	17
4.3 AMD Dual Graphics Setup	18
Chapter 5: Software & UEFI BIOS	19
5.1 Software.....	19
5.2 UEFI BIOS Setup	27
5.3 BIOS Update	27
Chapter 6: Useful Help	31
6.1 Driver Installation Note	31
6.2 AMI BIOS Beep Code.....	32
6.3 AMI BIOS Post Code.....	32
6.4 Troubleshooting.....	34
6.5 RAID Functions	36
Appendix: SPEC In Other Languages	38
Arabic	38
French	40
German.....	42
Italian	44
Japanese.....	46
Polish.....	48
Portuguese	50
Russian.....	52
Spanish.....	54

CHAPTER 1: INTRODUCTION

1.1 BEFORE YOU START

Thank you for choosing our product. Before you start installing the motherboard, please make sure you follow the instructions below:

- Prepare a dry and stable working environment with sufficient lighting.
- Always disconnect the computer from power outlet before operation.
- Before you take the motherboard out from anti-static bag, ground yourself properly by touching any safely grounded appliance, or use grounded wrist strap to remove the static charge.
- Avoid touching the components on motherboard or the rear side of the board unless necessary. Hold the board on the edge, do not try to bend or flex the board.
- Do not leave any unfastened small parts inside the case after installation. Loose parts will cause short circuits which may damage the equipment.
- Keep the computer from dangerous area, such as heat source, humid air and water.
- The operating temperatures of the computer should be 0 to 45 degrees Celsius.
- To avoid injury, be careful of:
 - Sharp pins on headers and connectors
 - Rough edges and sharp corners on the chassis
 - Damage to wires that could cause a short circuit

1.2 PACKAGE CHECKLIST

- Serial ATA Cable x4
- Rear I/O Panel for ATX Case x1
- User's Manual x1
- Fully Setup Driver DVD x1

Note: The package contents may be different due to the sales region or models in which it was sold. For more information about the standard package in your region, please contact your dealer or sales representative.

1.3 MOTHERBOARD FEATURES

Specifications	
CPU Support	Socket FM2+/FM2 for AMD A-series processor Maximum CPU TDP (Thermal Design Power): 100Watt * Please refer to www.biostar.com.tw for CPU support list.
Chipset	AMD A88X FCH
Memory	Supports Dual Channel DDR3 800/ 1066/ 1333/ 1600/ 1866/ 2133/ 2400(OC)/ 2600(OC) 4 x DDR3 DIMM Memory Slot, Max. Supports up to 64 GB Memory Each DIMM supports non-ECC 512MB/ 1/ 2/ 4/ 8/ 16 GB DDR3 module * Please refer to www.biostar.com.tw for Memory support list.
Storage	AMD A88X FCH 8x SATA 6Gb/s Connector Supports RAID 0,1,10,5 & AHCI
LAN	Realtek RTL 8111G 10/ 100/ 1000 Mb/s auto negotiation, Half / Full duplex capability
Audio Codec	ALC892, 7.1 Channels, High Definition Audio, Biostar Hi-Fi 3D
USB	4x USB 3.0 port (2 on rear I/Os and 2 via internal headers) 8x USB 2.0 port (4 on rear I/Os and 4 via internal headers)
Expansion Slots	2x PCI Slot 2x PCIe 2.0 x1 Slot 1x PCIe 3.0 x16 Slot (x16) (Only FM2+ processors can support PCIe 3.0.) 1x PCIe 2.0 x16 Slot (x4)
Rear I/Os	1x PS/2 Keyboard/ Mouse 1x HDMI Port 1x VGA Port 1x DVI Port 1x LAN port 4x USB 2.0 Port 2x USB 3.0 Port 6x Audio Jack
Internal I/Os	8x SATA 6.0Gb/s Connector 2x USB 2.0 Header (each header supports 2 USB 2.0 ports) 1x USB 3.0 Header (each header supports 2 USB 3.0 ports) 1x 4-Pin Power Connector 1x 24-Pin Power Connector 2x CPU Fan Connector 3x System Fan Connector 1x Front Panel Header 1x Front Audio Header 1x Clear CMOS Header 1x Consumer IR Header 1x Serial Port Header 1x S/PDIF out Connector
Form Factor	ATX Form Factor, 305mm x 235 mm
OS Support	Windows XP / 7/ 8 Biostar reserves the right to add or remove support for any OS with or without notice.

1.4 REAR PANEL CONNECTORS

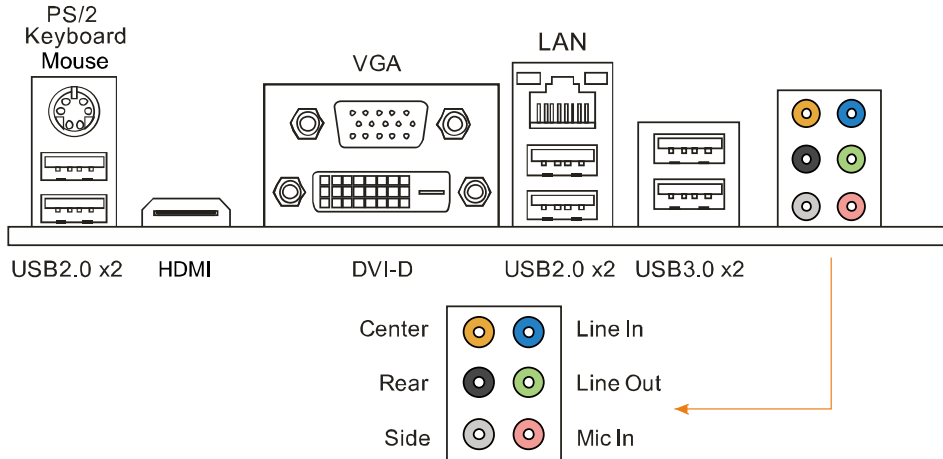

- Note 1:** HDMI / DVI-D / VGA Output require an AMD family processor with integrated graphics.
- Note 2:** The mainboard supports three independent display outputs.
- Note 3:** Since the audio chip supports High Definition Audio Specification, the function of each audio jack can be defined by software. The input / output function of each audio jack listed above represents the default setting. However, when connecting external microphone to the audio port, please use the Line In (Blue) and Mic In (Pink) audio jack.
- Note 4:** Maximum resolution:

Outputs	Maximum resolution	Bit Depth
HDMI	1920 x 1080 @60Hz	24, 30, 36 bpp
	1920 x 1200 @60Hz	24 bpp
DVI-D	1920 x 1200 @60Hz	30 bpp
	2560 x 1600 @60Hz	24 bpp
VGA	1920 x 1600 @60Hz	--

1.5 MOTHERBOARD LAYOUT

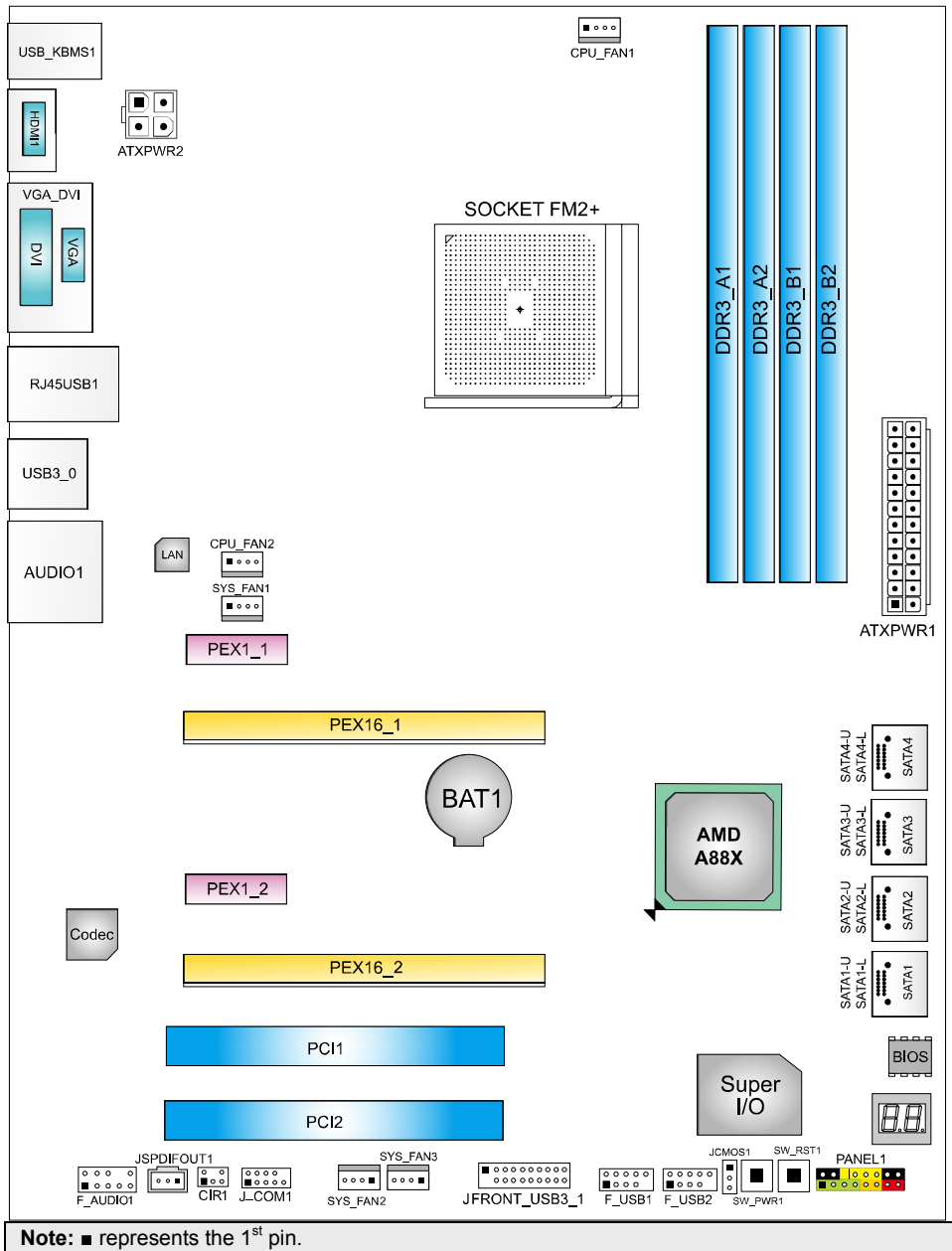

CHAPTER 2: HARDWARE INSTALLATION

2.1 INSTALLING CENTRAL PROCESSING UNIT (CPU)

Step 1: Locate the CPU socket on the motherboard

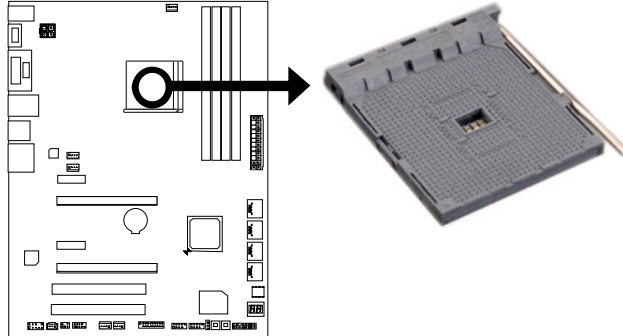

Step 2: Pull the socket locking out from the socket and then raise the lever up to a 90-degree angle.

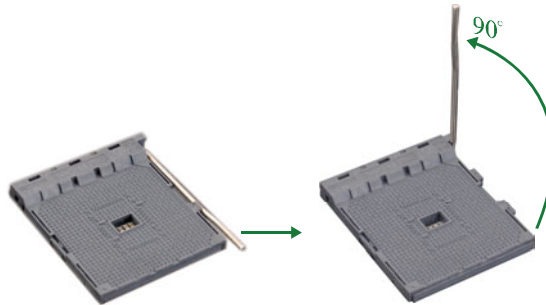

Step 3: Look for the white triangle on socket, and the gold triangle on CPU should point towards this white triangle. The CPU will fit only in the correct orientation.

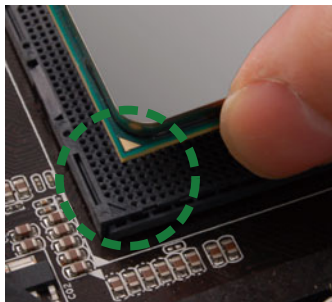

Step 4: Hold the CPU down firmly, and then close the lever to locked the position

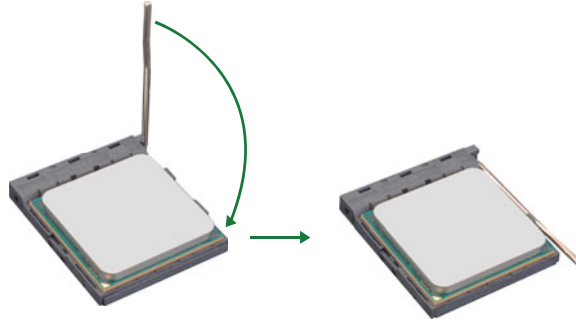

2.2 INSTALL A HEATSINK

Step 1: Place the heatsink and fan assembly onto the retention frame. Match the heatsink clip with the socket mounting-lug. Hook the spring clip to the mounting-lug.

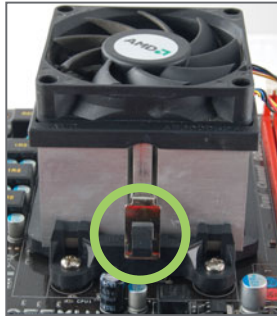

Step 2: On the other side, push the retention clip straight down to lock into the plastic lug on the retention frame, and then press down the locker until it stops.

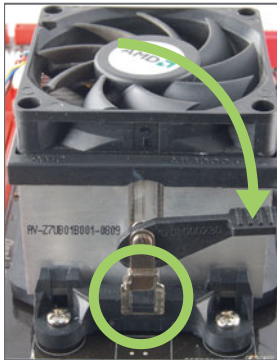

Note1: Do not forget to connect the CPU fan connector.
Note2: For proper installation, please kindly refer to the installation manual of your CPU heatsink.

2.3 FAN HEADERS

These fan headers support cooling-fans built in the computer. The fan cable and connector may be different according to the fan manufacturer. Connect the fan cable to the connector while matching the black wire to pin#1.

CPU_FAN1/2: CPU Fan Header

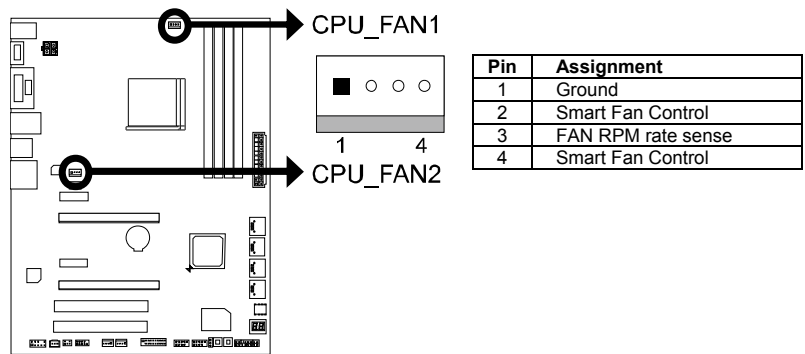

SYS_FAN1/2/3: System Fan Header

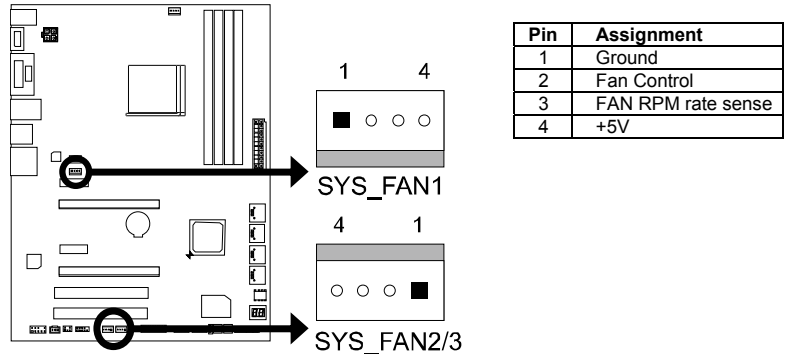

Note: CPU_FAN1/2, SYS_FAN1/2/3 support 4-pin and 3-pin head connectors. When connecting with wires onto connectors, please note that the red wire is the positive and should be connected to pin#2, and the black wire is Ground and should be connected to pin#1(GND).

2.4 INSTALLING SYSTEM MEMORY

A. DDR3 Modules

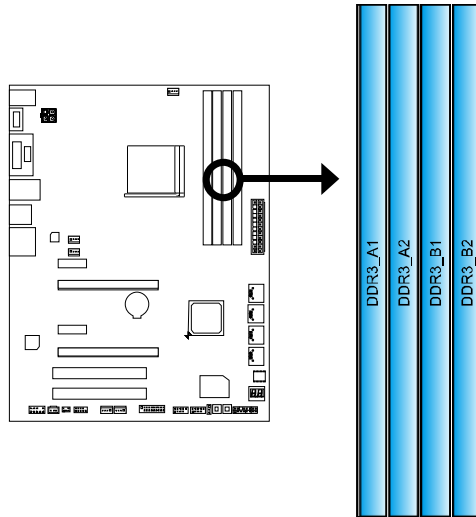

Step 1: Unlock a DIMM slot by pressing the retaining clips outward. Align a DIMM on the slot such that the notch on the DIMM matches the break on the slot.

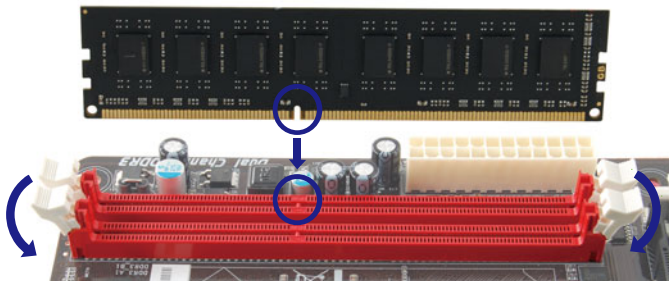

Step 2: Insert the DIMM vertically and firmly into the slot until the retaining clips snap back in place and the DIMM is properly seated.

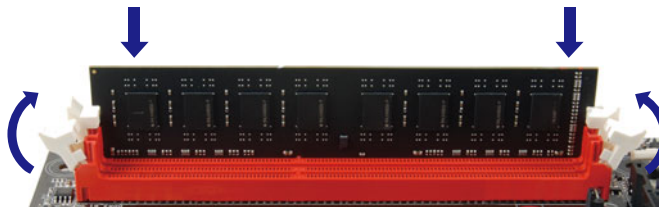

Note: If the DIMM does not go in smoothly, do not force it. Pull it all the way out and try again.

B. Memory Capacity

DIMM Socket Location	DDR3 Module	Total Memory Size
DDR3_A1	512MB/1GB/2GB/4GB/8GB/16GB	Max is 64GB.
DDR3_A2	512MB/1GB/2GB/4GB/8GB/16GB	
DDR3_B1	512MB/1GB/2GB/4GB/8GB/16GB	
DDR3_B2	512MB/1GB/2GB/4GB/8GB/16GB	

C. Dual Channel Memory Installation

Please refer to the following requirements to activate Dual Channel function:
 Install memory module of the same density in pairs, shown in the table.

Dual Channel Status	DDR3_A1	DDR3_A2	DDR3_B1	DDR3_B2
Enabled	O	X	O	X
Enabled	X	O	X	O
Enabled	O	O	O	O

(O means memory installed, X means memory not installed.)

2.5 CONNECTORS AND SLOTS

ATXPWR1: ATX Power Source Connector

For better compatibility, we recommend to use a standard ATX 24-pin power supply for this connector. Make sure to find the correct orientation before plugging the connector.

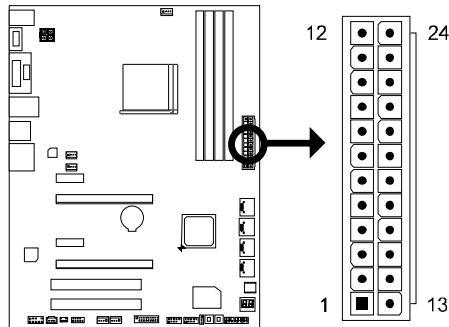

Pin	Assignment	Pin	Assignment
13	+3.3V	1	+3.3V
14	-12V	2	+3.3V
15	Ground	3	Ground
16	PS_ON	4	+5V
17	Ground	5	Ground
18	Ground	6	+5V
19	Ground	7	Ground
20	NC	8	PW_OK
21	+5V	9	Standby Voltage+5V
22	+5V	10	+12V
23	+5V	11	+12V
24	Ground	12	+3.3V

ATXPWR2: ATX Power Source Connector

This connector will provide +12V to CPU power circuit.

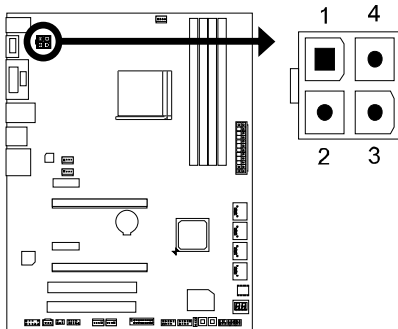

Pin	Assignment
1	+12V
2	+12V
3	Ground
4	Ground

Note1: Before you power on the system, please make sure that both ATXPWR1 and ATXPWR2 connectors have been plugged-in.

Note2: Insufficient power supplied to the system may result in instability or the peripherals not functioning properly. Use of a PSU with a higher power output is recommended when configuring a system with more power-consuming devices.

PEX1_1/1_2: PCI-Express Gen2 x1 Slot

- PCI-Express 2.0 compliant.
- Data transfer bandwidth up to 500MB/s per direction; 1GB/s in total

PEX16_1: PCI-Express Gen3 x16 Slot

- PCI-Express 3.0 compliant.
- Maximum theoretical realized bandwidth of 16GB/s simultaneously per direction, for an aggregate of 32GB/s totally.
- Only FM2+ processors can support PCIe 3.0.

PEX16_2: PCI-Express Gen2 x4 Slot

- PCI-Express 2.0 compliant.
- Data transfer bandwidth up to 2GB/s per direction; 4GB/s in total.

PCI1/2: Peripheral Component Interconnect Slot

This motherboard is equipped with 2 standard PCI slots. PCI stands for Peripheral Component Interconnect, and it is a bus standard for expansion cards.

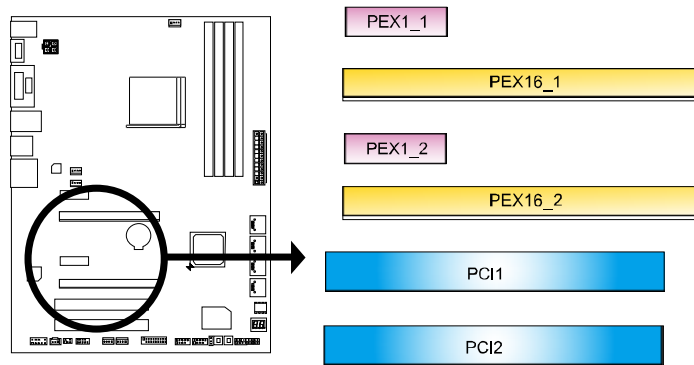

SATA1~SATA4: Serial ATA Connectors

These connectors connect to SATA hard disk drives via SATA cables.

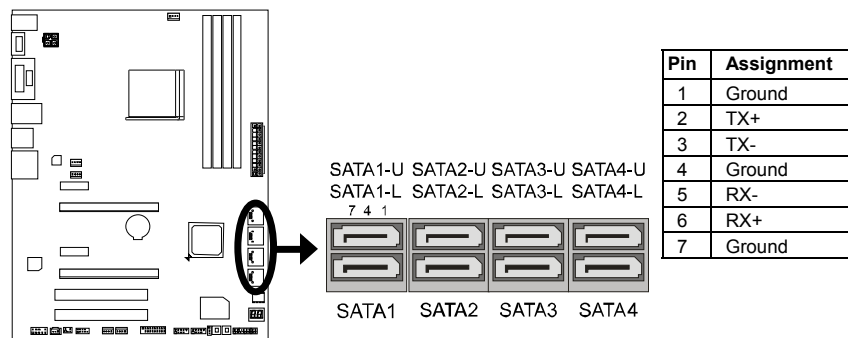

CHAPTER 3: HEADERS & JUMPERS SETUP

3.1 HOW TO SETUP JUMPERS

The illustration shows how to set up jumpers. When the jumper cap is placed on pins, the jumper is “close”, if not, that means the jumper is “open”.



JCMOS1: Clear CMOS Jumper

Placing the jumper on pin2-3, it allows user to restore the BIOS safe setting and the CMOS data. Please carefully follow the procedures to avoid damaging the motherboard.

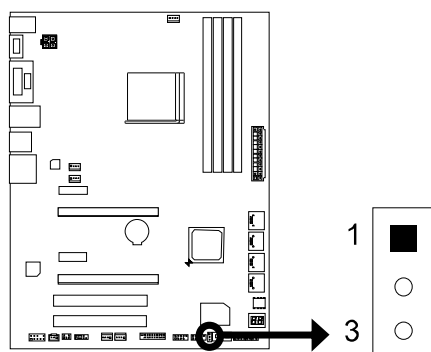

Pin 1-2 Close:
Normal Operation (default).



Pin 2-3 Close:
Clear CMOS data.

※ Clear CMOS Procedures:

1. Remove AC power line.
2. Set the jumper to “Pin 2-3 close”.
3. Wait for five seconds.
4. Set the jumper to “Pin 1-2 close”.
5. Power on the AC.
6. Load Optimal Defaults and save settings in CMOS.

3.2 DETAIL SETTINGS

PANEL1: Front Panel Header

This 16-pin connector includes Power-on, Reset, HDD LED, Power LED, and speaker connection. It allows user to connect the PC case's front panel switch functions.

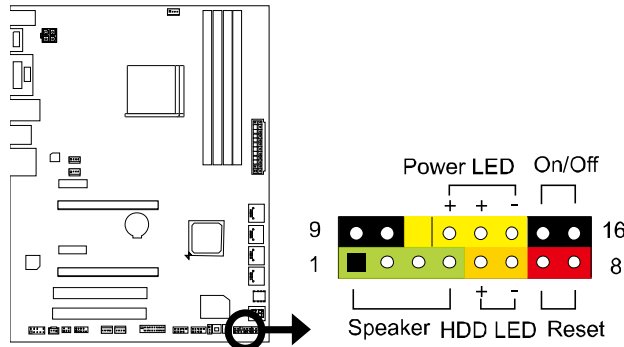

Pin	Assignment	Function	Pin	Assignment	Function
1	+5V	Speaker Connector	9	N/A	N/A
2	N/A		10	N/A	
3	N/A		11	N/A	
4	Speaker		12	Power LED (+)	Power LED
5	HDD LED (+)	13	Power LED (+)		
6	HDD LED (-)	Hard drive LED	14	Power LED (-)	
7	Ground		15	Power button	Power-on button
8	Reset control	Reset button	16	Ground	

F_USB1/F_USB2: Headers for USB 2.0 Ports at Front Panel

This header allows user to connect additional USB cable on the PC front panel, and also can be connected with a wide range of simultaneously accessible external Plug and Play peripherals.

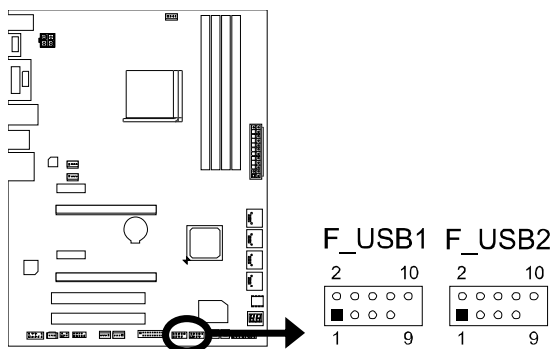

Pin	Assignment
1	+5V (fused)
2	+5V (fused)
3	USB-
4	USB-
5	USB+
6	USB+
7	Ground
8	Ground
9	NC
10	Key

JFRONT_USB3_1: Header for USB 3.0 Ports at Front Panel

This header allows user to connect additional USB cable on the PC front panel, and also can be connected with a wide range of simultaneously accessible external Plug and Play peripherals.

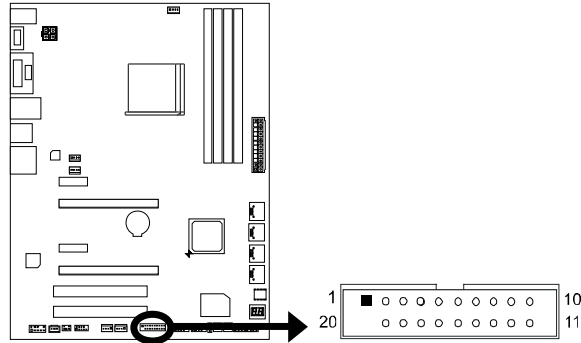

Pin	Assignment	Pin	Assignment
1	VBUS0	11	D2+
2	SSRX1-	12	D2-
3	SSRX1+	13	Ground
4	Ground	14	SSTX2+
5	SSTX1-	15	SSTX2-
6	SSTX1+	16	Ground
7	Ground	17	SSRX2+
8	D1-	18	SSRX2-
9	D1+	19	VBUS1
10	ID	20	Key

JSPDIFOUT1: Digital Audio-out Connectors

The JSPDIFOUT1 is for connecting the PCI bracket SPDIF output.

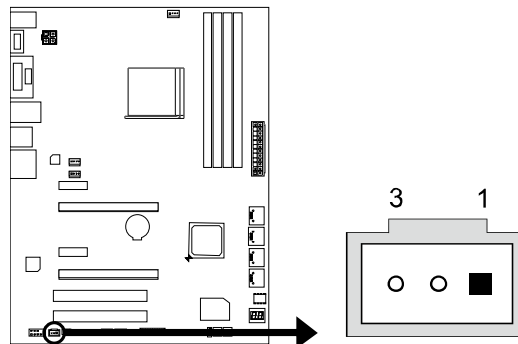

Pin	Assignment
1	+5V
2	SPDIF_OUT
3	Ground

F_AUDIO1: Front Panel Audio Header

This header allows user to connect the front audio output cable with the PC front panel. This header supports HD and AC'97 audio front panel connector.

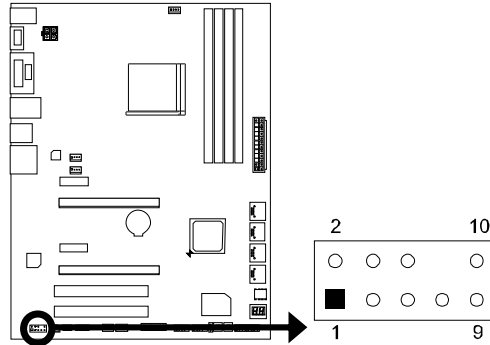

HD Audio		AC'97	
Pin	Assignment	Pin	Assignment
1	Mic Left in	1	Mic In
2	Ground	2	Ground
3	Mic Right in	3	Mic Power
4	GPIO	4	Audio Power
5	Right line in	5	RT Line Out
6	Jack Sense	6	RT Line Out
7	Front Sense	7	Reserved
8	Key	8	Key
9	Left line in	9	LFT Line Out
10	Jack Sense	10	LFT Line Out

Note1: It is recommended that you connect a high-definition front panel audio module to this connector to avail of the motherboard's high definition audio capability.
Note2: Please try to disable the "Front Panel Jack Detection" if you want to use an AC'97 front audio output cable. The function can be found via O.S. Audio Utility.

J_COM1: Serial Port Header

The motherboard has a serial port Header for connecting RS-232 Port.

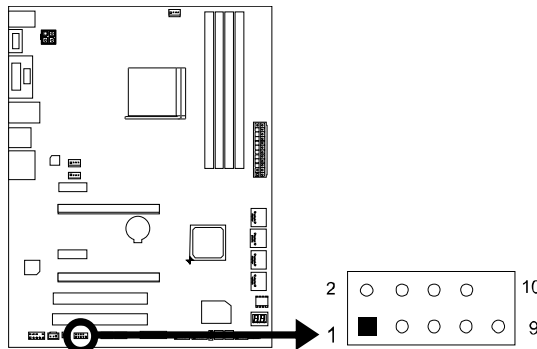

Pi	Assignment
1	Carrier detect
2	Received data
3	Transmitted data
4	Data terminal ready
5	Signal ground
6	Data set ready
7	Request to send
8	Clear to send
9	Ring indicator
10	NC

CIR1: Consumer IR Header

This header is for infrared remote control and communication.

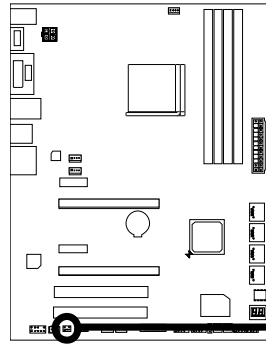

Pin	Assignment
1	IrDA serial input
2	Ground
3	Ground
4	Key
5	IrDA serial output
6	IR Power

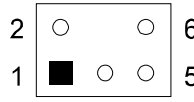

On-Board Buttons

There are 2 on-board buttons.

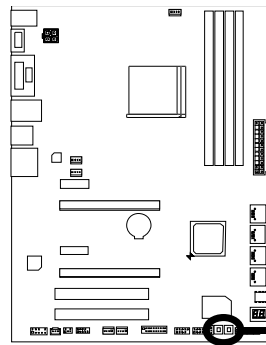

SW_PWR1:

This is an on-board Power Switch button.

SW_RST1:

This is an on-board Reset button.

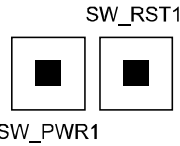

BIOS POST Code/CPU Temperature Indicator

This indicator will show POST code while booting. After the booting sequence, it will show current CPU temperature. Please refer to Chapter 6.3 for all the BIOS POST codes.

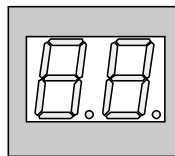
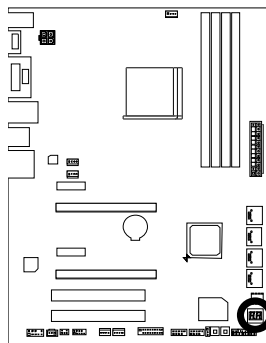

CHAPTER 4: AMD DUAL GRAPHICS TECHNOLOGY

4.1 AMD DUAL GRAPHICS TECHNOLOGY INTRODUCTION

When user adds a AMD PCIe display adapter, it can be integrated with IGD to show better performance. To make the two video devices work simultaneously and normally, please refer to the following setting.

4.2 AMD DUAL GRAPHICS REQUIREMENT

- Operating System: Windows 7 / Windows 8
- Supported Dual Graphics Combinations:

Richland APUs			
AMD Radeon™ Graphics Card	A10-Series HD 8670D	A8-Series HD8570D	A6-Series HD 8470D
“Oland” XT, HD 8870	●	●	●(Note2)
“Oland” Pro, HD 8850	●	●	●
“Turks” XT, HD 6670	●	●	●
“Turks” Pro, HD 6570	●	●	●
“Caicos” Pro, HD 6450	●	●	●
Trinity APUs			
AMD Radeon™ Graphics Card	A10-Series HD 7660D	A8-Series HD7560D	A6-Series HD 7540D
“Turks” XT, HD 6670	●	●	--
“Turks” Pro, HD 6570	●	●	●
“Caicos” Pro, HD 6450	--	--	●

- Recommended graphics cards for AMD dual-graphics

Note 1: A4-Series CPUs do not support Dual Graphics.

Note 2: Only available for DDR3 graphics memory

Note 3: The information described above in this manual is for your reference only and the actual information and settings on board may be different from this manual. For further AMD Dual Graphics information, please visit the following website: <http://www.amd.com>

4.3 AMD DUAL GRAPHICS SETUP

Step 1: Insert Dual Graphics-Ready graphics card into PEX16_1 slot.

Step 2: Set the BIOS setting as follows:
[Chipset]→[North Bridge]→[Surround View]→[Enabled]

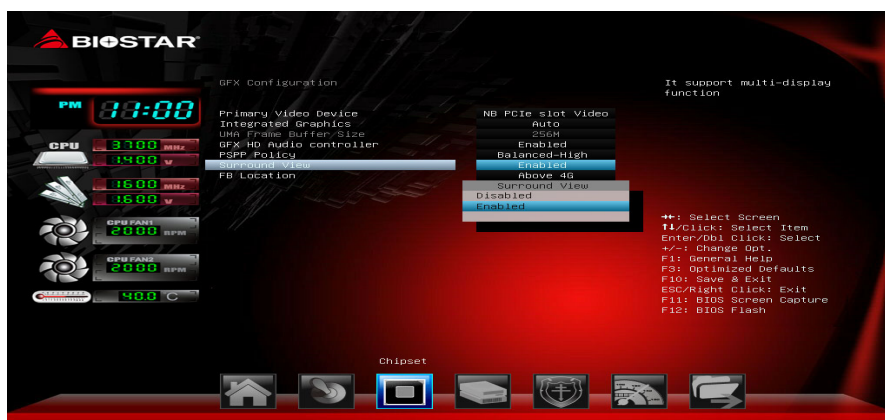

Step 3: Install Driver DVD Chipset Driver, and reboot the system. Activate AMD VISION Engine Control Center to make sure CrossFire has been enabled.

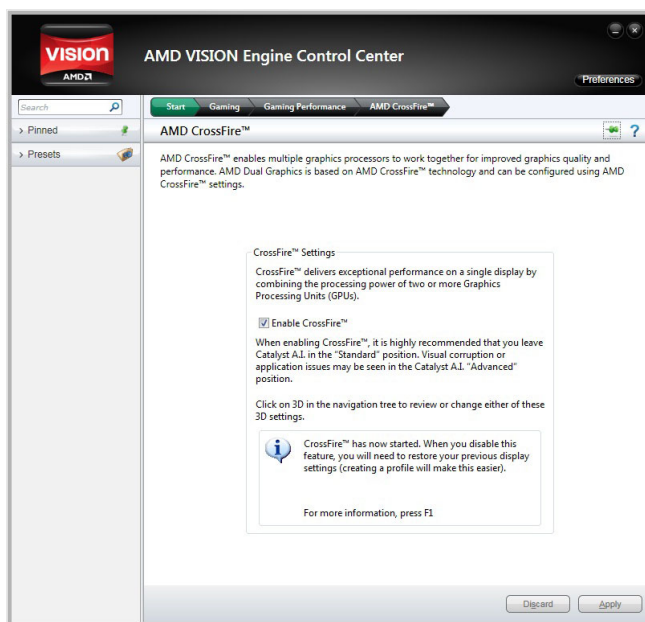

CHAPTER 5: SOFTWARE & UEFI BIOS

5.1 SOFTWARE

Installing Software

1. Insert the Setup DVD to the optical drive. The driver installation program would appear if the Auto-run function has been enabled.
2. Select **Software Installation**, and then click on the respective software title.
3. Follow the on-screen instructions to complete the installation.

Launching Software

After the installation process is completed, you will see the software icon showing on the desktop. Double-click the icon to launch it.

Note1: All the information and content about following software are subject to be changed without notice. For better performance, the software is being continuously updated.

Note2: The information and pictures described below are for your reference only. The actual information and settings on board may be slightly different from this manual.

TOverclocker

TOverclocker presents a simple Windows-based system performance enhancement and manageability utility. It features several powerful and easy to use tools such as Overclocking for enhancing system performance, also for special enhancement on CPU and Memory. Smart-Fan management and PC health are for monitoring system status. This utility also allows you to make overclocking profiles saving unlimitedly, and pre-set OC modes are for easy OC. (The screenshots below are for reference only)

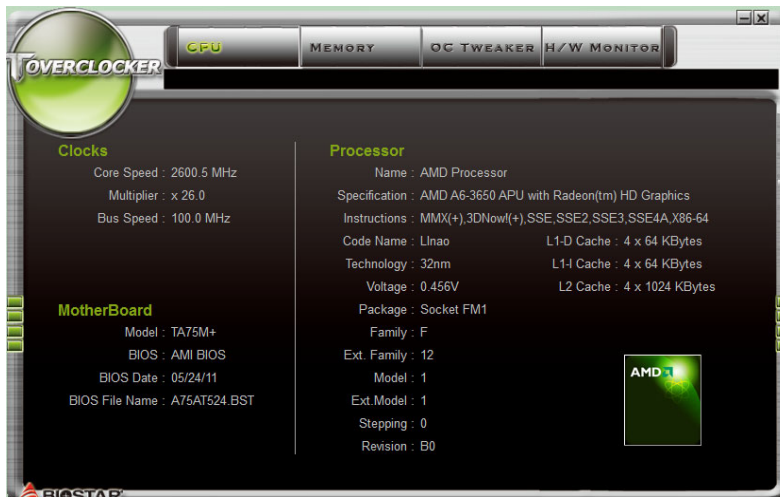

CPU

The **CPU** tab provides information on the CPU and motherboard.

MEMORY

The **Memory** tab provides information on the memory module(s). You can select memory module on a specific slot to see its information.

Motherboard Manual

OC TWEAKER

The **OC Tweaker** tab allows you to save or load the OC setting profiles, change system frequency and voltage settings.

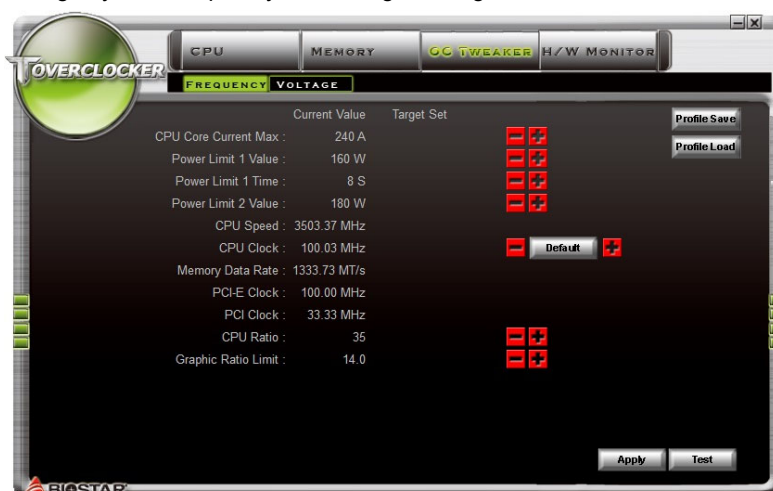

H/W MONITOR

The **HW Monitor** tab allows you to monitor hardware voltage, fan speed, and temperature. You can also set CPU Smart Fan function in this tab.



Note1: Not all types of CPU perform above overclock setting ideally; the difference will be based on the selected CPU model.

Note2: Overclock is an optional process, but not a "must-do" process; it is not recommended for inexperienced users. Therefore, we will not be responsible for any hardware damage which may be caused by overclocking. We also would not guarantee any overclocking performance.

Note3: Press **TOVERCLOCKER** logo, it will display information about manufacturer and software version. You can update latest version by clicking the "**Live Update**" button.

Green Power II Utility

BIOSTAR G.P.U II (Green Power Utility) is a new function. The utility enhances energy efficiency by disabling extra phases while CPU is on light loading; it features 4+1 power phases, current power saving, and total power saving. This tool integrates a friendly GUI to monitor your CPU Usage, CPU Watt, and CPU Temperature. Moreover, it optimizes power saving and best power efficiency on your system. (The illustration below is for reference only)

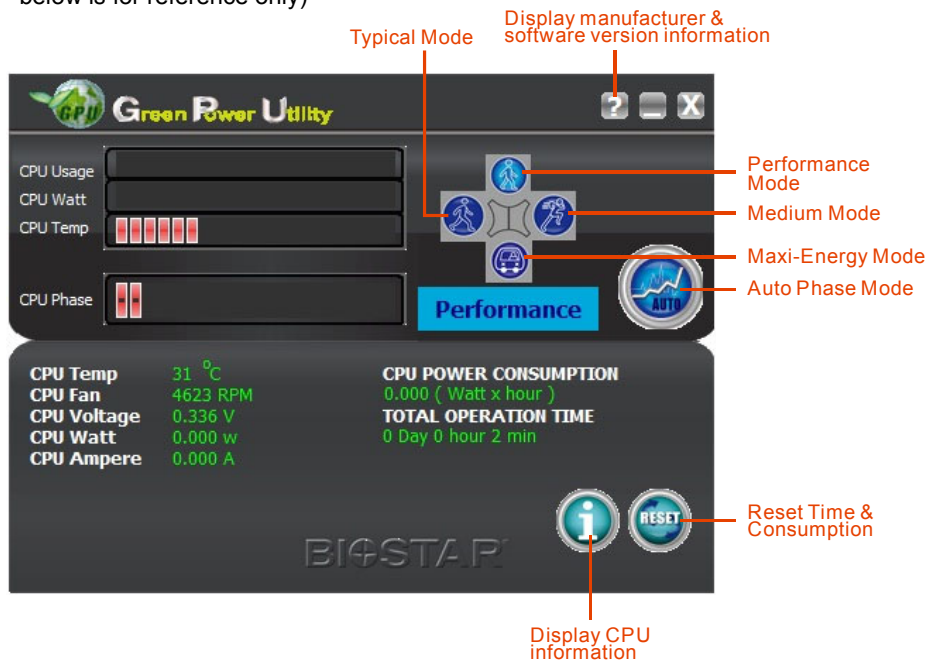

G.P.U Mode Setting:

This utility provides five modes, upon your requirements, to improve system performance or to save power consumption.

Note: Even if the modes saving more power consumption are chosen, the system still can keep excellent performance.

- **Auto Phase Mode:** System switches the mode automatically according to current system loading condition.
- **Performance Mode:** This is the mode saving power consumption most. Least energy will be used in the system.
- **Typical Mode:** Compared with that in Performance Mode, energy consumption in this mode is a little bit more.
- **Medium Mode:** The standard system power saving mode.
- **Maxi-Energy Mode:** The best system performance mode.

Smart EAR 3D

Hi-Fi 3D Audio Requirements:

1. A chassis with front audio output jacks
2. An earphone or a headphone
3. Speakers
4. Windows 7 or Windows 8 operation system

Installation Guide:

1. Make sure the front audio cable of the chassis connected to the front audio header of the motherboard properly.
2. Install the Smart Ear 3D Utility from the driver DVD.
3. Connect the earphone or headphone to the front audio jack of the chassis for Smart Gain and 3D Sound Field functions.

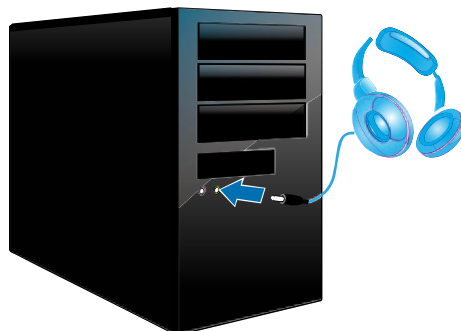

4. Connect the speakers to **line out port** (green color) of rear panel for Smart PREAMP function.

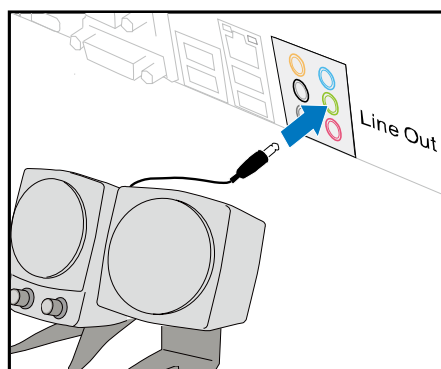

Note: If you want to use an AC'97 front audio output cable, please disable the "Front Panel Jack Detection" setting. This setting can be found via O.S. Audio Utility.

Smart EAR 3D Utility:

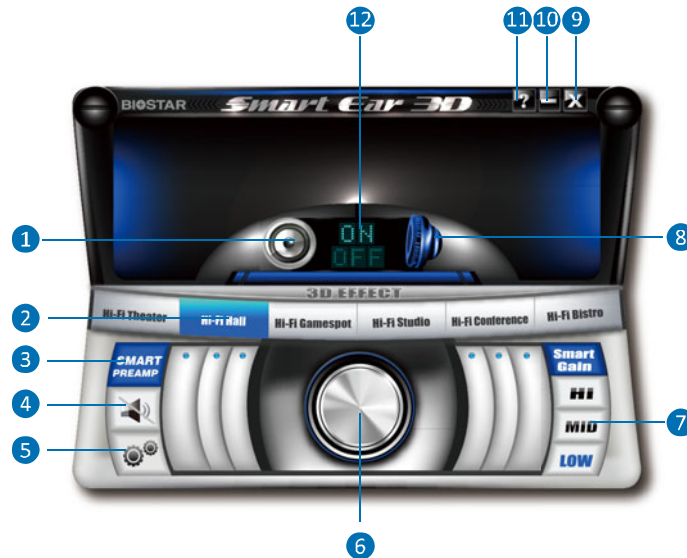

1. **Rear Panel Audio Output Indicator:** It displays a blue light when the audio output is from rear panel “Line Out” ports.
2. **3D Sound Field Button:** There are six sound environment options for achieving realistic listening experience. It displays a blue light when the 3D Sound Field is enabled.
3. **Smart PREAMP Button:** Click this switch to turn on or off the Smart PREAMP function.
4. **Mute Button:** To disable system sound
5. **Control Button:** It allows you to set utility preference.
6. **Volume Control Knob:** The volume can be finely adjusted by turning the knob either clockwise or anti-clockwise to increase or decrease system volume accordingly.
7. **Headphone Hi/Mid/Low Gain Switch:** It allows you to select headphone gain settings or you can let the software auto adjust headphone gain setting appropriate for your headphones. The Smart Gain function will be enabled when the 3D Sound Field Button is turned on.
8. **Front Panel Audio Output Indicator:** It displays a blue light when the audio output is from front panel port.
9. **Exit Button:** Exit the application
10. **Minimize Button:** Minimize the application window to the taskbar
11. **Information Button:** Get information of the application
12. **Smart PREAMP or Smart Gain ON/OFF Indicator:** When the Rear Panel Audio Output Indicator is lit, it shows Smart PREAMP on/off status. When the Front Panel Audio Output Indicator is lit, it shows Smart Gain on/off status.

Note1: The 3D Sound Field function is only for front panel audio output.

Note2: The Smart PREAMP function is only for rear panel audio output.

Note3: When both rear and front panels are connected with audio devices, the default audio output is from front panel.

eHot-Line

eHot-Line is a convenient utility that helps you to contact with our Tech-Support system. This utility will collect the system information which is useful for analyzing the problem you may have encountered, and then send these information to our tech-support department to help you fix the problem.

Note: Before you use this utility, please set Outlook Express as your default e-mail client application program.

*represents important information that you must provide. Without this information, you may not be able to send out the mail.

This block will show the information which would be collected in the mail.

*Describe condition of your system.

*Select your area or the area close to you.

Provide the e-mail address that you would like to send the copy to.

*Provide the name of the memory module manufacturer.

Provide the name of the power supply manufacturer and the model no.

Send the mail out.

Save these information to a .txt file

Exit this dialog.

After filling up this information, click “Send” to send the mail out. A warning dialog would appear asking for your confirmation; click “Send” to confirm or “Do Not Send” to cancel.

If you want to save this information to a .txt file, click “Save As...” and then you will see a saving dialog appears asking you to enter file name.

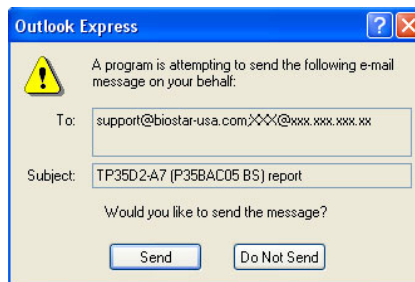

Enter the file name and then click “Save”. Your system information will be saved to a .txt file.

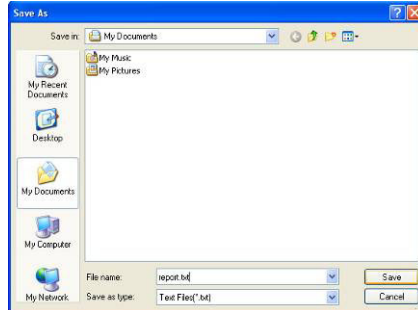

Open the saved .txt file, you will see your system information including motherboard/BIOS/CPU/video/ device/OS information. This information is also concluded in the sent mail.

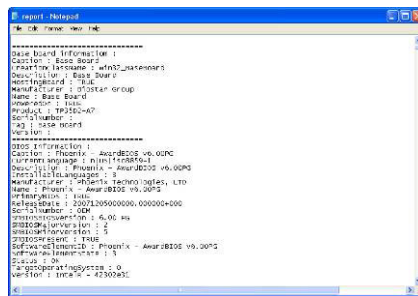

Note1: We will not share customer's data with any other third parties, so please feel free to provide your system information while using eHot-Line service.

Note2: If you are not using Outlook Express as your default e-mail client application, you may need to save the system information to a .txt file and send the file to our tech support with other e-mail application. Go to the following website <http://www.biostar.com.tw/app/en/about/contact.php> for getting our contact information.

BIOScreen Utility

This utility allows you to personalize your boot logo easily. You can choose BMP as your boot logo so as to customize your computer.

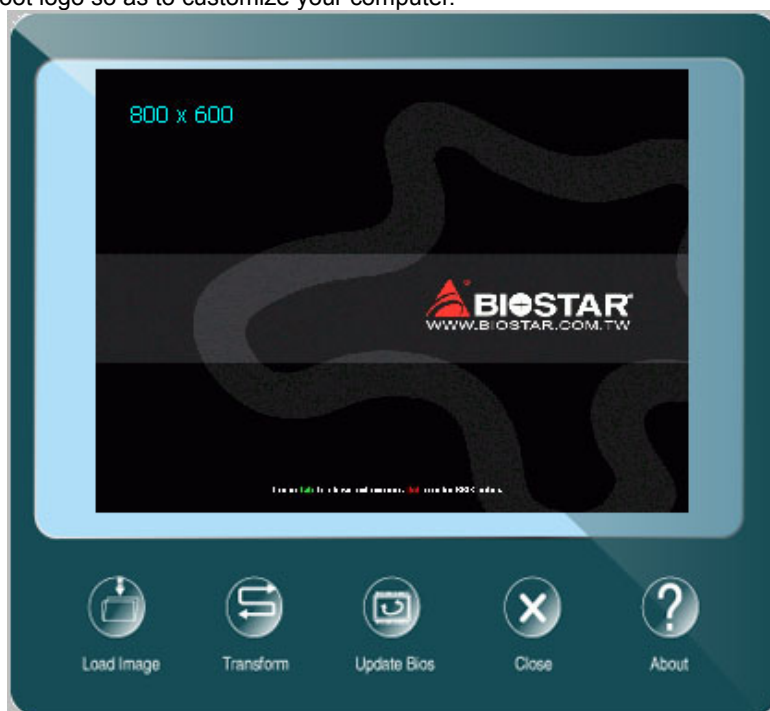

Please follow the step-by-step instructions below to update boot logo:

- Load Image : Choose the picture as the boot logo.
- Transform : Transform the picture for BIOS and preview the result.
- Update Bios : Write the picture to BIOS Memory to complete the update.

5.2 UEFI BIOS SETUP

- The BIOS Setup program can be used to view and change the BIOS settings for the computer. The BIOS Setup program is accessed by pressing the key after the Power-On Self-Test (POST) memory test begins and before the operating system boot begins.
- For further information of setting up the UEFI BIOS, please refer to the UEFI BIOS Manual in the Setup DVD.

5.3 BIOS UPDATE

The BIOS can be updated using either of the following utilities:

- **BIOSTAR BIOS Flasher:** Using this utility, the BIOS can be updated from a file on a hard disk, a USB drive (a flash drive or a USB hard drive), or a CD-ROM.
- **BIOSTAR BIOS Update Utility:** It enables automated updating while in the Windows environment. Using this utility, the BIOS can be updated from a file on a hard disk, a USB drive (a flash drive or a USB hard drive), or a CD-ROM, or from the file location on the Web.

BIOSTAR BIOS Flasher

BIOSTAR BIOS Flasher is a BIOS flashing utility providing you an easy and simple way to update your BIOS via USB pen drive.

Note1: This utility only allows storage device with FAT32/16 format and single partition.

Note2: Shutting down or resetting the system while updating the BIOS will lead to system boot failure.

Updating BIOS with BIOSTAR BIOS Flasher

1. Go to the website to download the latest BIOS file for the motherboard.
2. Then, copy and save the BIOS file into a USB flash (pen) drive.
3. Insert the USB pen drive that contains the BIOS file to the USB port.
4. Power on or reset the computer and then press <F12> during the POST process.

5. After entering the POST screen, the BIOS-FLASHER utility pops out. Choose [fs0] to search for the BIOS file.



6. Select the proper BIOS file, and a message asking if you are sure to flash the BIOS file. Click Yes to start updating BIOS.



7. A dialog pops out after BIOS flash is completed, asking you to restart the system. Press the [Y] key to restart system.

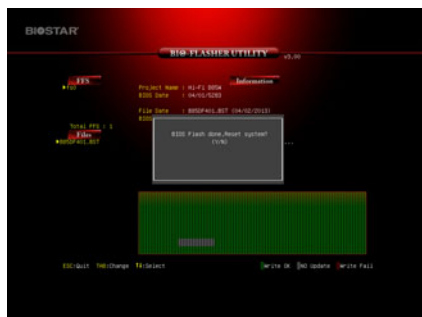

8. While the system boots up and the full screen logo shows up, press key to enter BIOS setup. After entering the BIOS setup, please go to the **Save & Exit**, using the **Restore Defaults** function to load Optimized Defaults, and select **Save Changes and Reset** to restart the computer. Then, the BIOS Update is completed.

BIOS Update Utility (through the Internet)

1. Installing BIOS Update Utility from the DVD Driver.
2. Please make sure the system is connected to the internet before using this function.

3. Launch BIOS Update Utility and click the **Online Update** button on the main screen.



- An open dialog will show up to request your agreement to start the BIOS update. Click **Yes** to start the online update procedure.

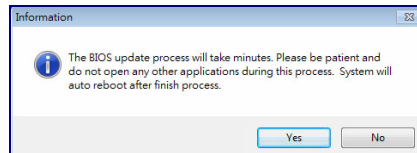

- If there is a new BIOS version, the utility will ask you to download it. Click **Yes** to proceed.

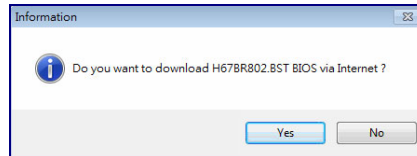

- After the download is completed, you will be asked to program (update) the BIOS or not. Click **Yes** to proceed.

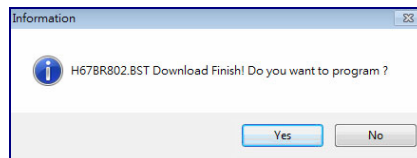

- After the updating process is finished, you will be asked you to reboot the system. Click **OK** to reboot.

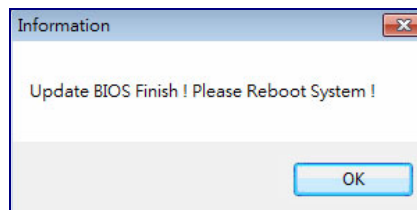

- While the system boots up and the full screen logo shows up, press key to enter BIOS setup. After entering the BIOS setup, please go to the **Save & Exit**, using the **Restore Defaults** function to load Optimized Defaults, and select **Save Changes and Reset** to restart the computer. Then, the BIOS Update is completed.

BIOS Update Utility (through a BIOS file)

- Installing BIOS Update Utility from the DVD Driver.
- Download the proper BIOS from <http://www.biostar.com.tw/>

- Launch BIOS Update Utility and click the **Update BIOS** button on the main screen.



4. A warning message will show up to request your agreement to start the BIOS update. Click **OK** to start the update procedure.

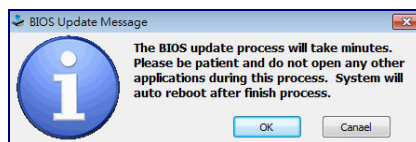

5. Choose the location for your BIOS file in the system. Please select the proper BIOS file, and then click on **Open**. It will take several minutes, please be patient.

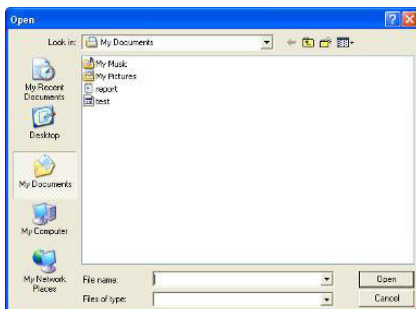

6. After the BIOS Update process is finished, click on **OK** to reboot the system.

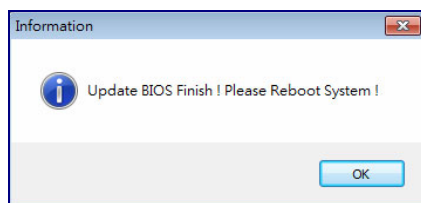

7. While the system boots up and the full screen logo shows up, press key to enter BIOS setup. After entering the BIOS setup, please go to the **Save & Exit**, using the **Restore Defaults** function to load Optimized Defaults, and select **Save Changes and Reset** to restart the computer. Then, the BIOS Update is completed.

Backup BIOS

Click the Backup BIOS button on the main screen for the backup of BIOS, and select a proper location for your backup BIOS file in the system, and click **Save**.

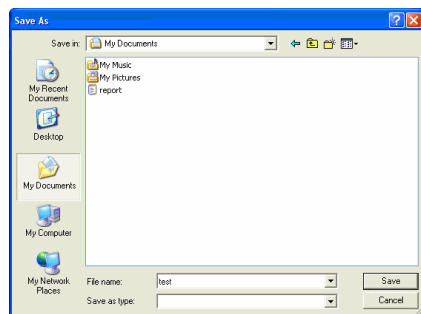

CHAPTER 6: USEFUL HELP

6.1 DRIVER INSTALLATION NOTE

After you installed your operating system, please insert the Fully Setup Driver DVD into your optical drive and install the driver for better system performance.

You will see the following window after you insert the DVD



The setup guide will auto detect your motherboard and operating system.

A. Driver Installation

To install the driver, please click on the Driver icon. The setup guide will list the compatible driver for your motherboard and operating system. Click on each device driver to launch the installation program.

B. Software Installation

To install the software, please click on the Software icon. The setup guide will list the software available for your system, click on each software title to launch the installation program.

C. Manual

Aside from the paperback manual, we also provide manual in the Driver DVD. Click on the Manual icon to browse for available manual.

Note1: If this window didn't show up after you insert the Driver DVD, please use file browser to locate and execute the file SETUP.EXE under your optical drive.

Note2: You will need Acrobat Reader to open the manual file. Please download the latest version of Acrobat Reader software from <http://get.adobe.com/reader/>

6.2 AMI BIOS BEEP CODE

Boot Block Beep Codes

Number of Beeps	Description
Continuing	Memory sizing error or Memory module not found

POST BIOS Beep Codes

Number of Beeps	Description
1	Success booting.
8	Display memory error (system video adapter)

6.3 AMI BIOS POST CODE

Code	Description
10	PEI Core is started
11	Pre-memory CPU initialization is started
15	Pre-memory North Bridge initialization is started
19	Pre-memory South Bridge initialization is started
2B	Memory initialization. Serial Presence Detect (SPD) data reading
2C	Memory initialization. Memory presence detection
2D	Memory initialization. Programming memory timing information
2E	Memory initialization. Configuring memory
2F	Memory initialization (other).
31	Memory Installed
32	CPU post-memory initialization is started
33	CPU post-memory initialization. Cache initialization
34	CPU post-memory initialization. Application Processor(s) (AP) initialization
35	CPU post-memory initialization. Boot Strap Processor (BSP) selection
36	CPU post-memory initialization. System Management Mode (SMM) initialization
37	Post-Memory North Bridge initialization is started
3B	Post-Memory North Bridge initialization (North Bridge module specific)
4F	DXE IPL is started
60	DXE Core is started
F0	Recovery condition triggered by firmware (Auto recovery)
F1	Recovery condition triggered by user (Forced recovery)
F2	Recovery process started
F3	Recovery firmware image is found
F4	Recovery firmware image is loaded
E0	S3 Resume is started (S3 Resume PPI is called by the DXE IPL)
E1	S3 Boot Script execution
E2	Video repost
E3	OS S3 wake vector call
60	DXE Core is started
61	NVRAM initialization
62	Installation of the South Bridge Runtime Services
63	CPU DXE initialization is started
68	PCI host bridge initialization
69	North Bridge DXE initialization is started
6A	North Bridge DXE SMM initialization is started
70	South Bridge DXE initialization is started

Code	Description
71	South Bridge DXE SMM initialization is started
72	South Bridge devices initialization
78	South Bridge DXE Initialization (South Bridge module specific)
79	ACPI module initialization
90	Boot Device Selection (BDS) phase is started
91	Driver connecting is started
92	PCI Bus initialization is started
93	PCI Bus Hot Plug Controller Initialization
94	PCI Bus Enumeration
95	PCI Bus Request Resources
96	PCI Bus Assign Resources
97	Console Output devices connect
98	Console input devices connect
99	Super IO Initialization
9A	USB initialization is started
9B	USB Reset
9C	USB Detect
9D	USB Enable
A0	IDE initialization is started
A1	IDE Reset
A2	IDE Detect
A3	IDE Enable
A4	SCSI initialization is started
A5	SCSI Reset
A6	SCSI Detect
A7	SCSI Enable
A8	Setup Verifying Password
A9	Start of Setup
AB	Setup Input Wait
AD	Ready To Boot event
AE	Legacy Boot event
AF	Exit Boot Services event
B0	Runtime Set Virtual Address MAP Begin
B1	Runtime Set Virtual Address MAP End
B2	Legacy Option ROM Initialization
B3	System Reset
B4	USB hot plug
B5	PCI bus hot plug
B6	Clean-up of NVRAM
B7	Configuration Reset (reset of NVRAM settings)

Note: If the post code is not listed on above table, please feel free contact our technical support.

6.4 TROUBLESHOOTING

Probable	Solution
<ol style="list-style-type: none"> 1. There is no power in the system. Power LED does not shine; the fan of the power supply does not work 2. Indicator light on keyboard does not shine. 	<ol style="list-style-type: none"> 1. Make sure power cable is securely plugged in. 2. Replace cable. 3. Contact technical support.
System is inoperative. Keyboard lights are on, power indicator lights are lit, and hard drives are running.	Using even pressure on both ends of the DIMM, press down firmly until the module snaps into place.
System does not boot from a hard disk drive, but can be booted from optical drive.	<ol style="list-style-type: none"> 1. Check cable running from disk to disk controller board. Make sure both ends are securely plugged in; check the drive type in the standard CMOS setup. 2. Backing up the hard drive is extremely important. All hard disks are capable of breaking down at any time.
System only boots from an optical drive. Hard disks can be read, applications can be used, but system fails to boot from a hard disk.	<ol style="list-style-type: none"> 1. Back up data and applications files. 2. Reformat the hard drive. Re-install applications and data using backup disks.
Screen message shows "Invalid Configuration" or "CMOS Failure."	Review system's equipment. Make sure correct information is in setup.
System cannot boot after user installs a second hard drive.	<ol style="list-style-type: none"> 1. Set master/slave jumpers correctly. 2. Run SETUP program and select correct drive types. Call the drive manufacturers for compatibility with other drives.

CPU Overheated

If the system shutdown automatically after power on system for seconds, that means the CPU protection function has been activated.

When the CPU is over heated, the motherboard will shutdown automatically to avoid a damage of the CPU, and the system may not power on again.

In this case, please double check:

1. The CPU cooler surface is placed evenly with the CPU surface.
2. CPU fan is rotated normally.
3. CPU fan speed is fulfilling with the CPU speed.

After confirmed, please follow steps below to relief the CPU protection function.

1. Remove the power cord from power supply for seconds.
2. Wait for seconds.
3. Plug in the power cord and boot up the system.

Or you can:

1. Clear the CMOS data.
(See "Close CMOS Header: JCMOS1" section)
2. Wait for seconds.
3. Power on the system again.

6.5 RAID FUNCTIONS

RAID Definitions

RAID 0:

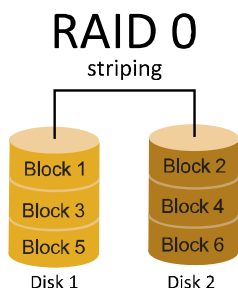

In a RAID 0 system data are split up in blocks that get written across all the drives in the array. By using multiple disks (at least 2) at the same time, this offers superior I/O performance. This performance can be enhanced further by using multiple controllers, ideally one controller per disk.

Features and Benefits

- **Drives:** Minimum 2, and maximum is up to 6 or 8. Depending on the platform.
- **Uses:** Intended for non-critical data requiring high data throughput, or any environment that does not require fault tolerance.
- **Benefits:** provides increased data throughput, especially for large files. No capacity loss penalty for parity.
- **Drawbacks:** Does not deliver any fault tolerance. If any drive in the array fails, all data is lost.
- **Fault Tolerance:** No.
- **Total Capacity:** (Minimal. HDD Capacity) x (Connected HDDs Amount)

RAID 1:

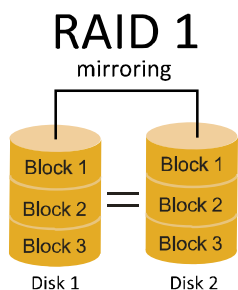

Data are stored twice by writing them to both the data disk (or set of data disks) and a mirror disk (or set of disks). If a disk fails, the controller uses either the data drive or the mirror drive for data recovery and continues operation. You need at least 2 disks for a RAID 1 array.

Features and Benefits

- **Drives:** Minimum 2, and maximum is 2.
- **Uses:** RAID 1 is ideal for small databases or any other application that requires fault tolerance and minimal capacity.
- **Benefits:** Provides 100% data redundancy. Should one drive fail, the controller switches to the other drive.
- **Drawbacks:** Requires 2 drives for the storage space of one drive. Performance is impaired during drive rebuilds.
- **Fault Tolerance:** Yes..

RAID 10:

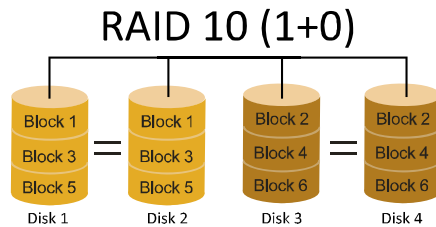

RAID 10 combines the advantages (and disadvantages) of RAID 0 and RAID 1 in one single system. It provides security by mirroring all data on a secondary set of disks (disk 3 and 4 in the drawing below) while using striping across each set of disks to speed up data transfers.

Features and Benefits

- **Drives:** Minimum 4, and maximum is 6 or 8, depending on the platform.
- **Benefits:** Optimizes for both fault tolerance and performance, allowing for automatic redundancy. May be simultaneously used with other RAID levels in an array, and allows for spare disks.
- **Drawbacks:** Requires twice the available disk space for data redundancy, the same as RAID level 1.
- **Fault Tolerance:** Yes.

RAID 5:

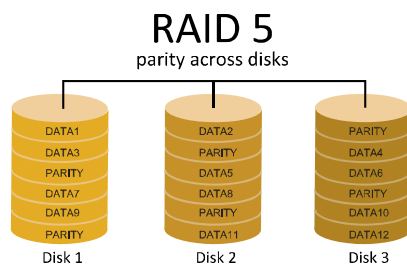

A RAID 5 array can withstand a single disk failure without losing data or access to data. Although RAID 5 can be achieved in software, a hardware controller is recommended. Often extra cache memory is used on these controllers to improve the write performance.

Features and Benefits

- **Drives:** Minimum 3.
- **Uses:** RAID 5 is recommended for transaction processing and general purpose service.
- **Benefits:** An ideal combination of good performance, good fault tolerance, and high capacity and storage efficiency.
- **Drawbacks:** Individual block data transfer rate same as a single disk. Write performance can be CPU intensive.
- **Fault Tolerance:** Yes.

APPENDIX: SPEC IN OTHER LANGUAGES

ARABIC

المواصفات	
المأخذ FM2+/FM2 لمعالج ايه إم دي AMD تنسلسل A الحد الأقصى للطاقة الحرارية في تصميم المعالج (TDP – thermal design power) : 100 واط. * يرجى الرجوع إلى الموقع www.biostar.com.tw لقائمة دعم المعالج CPU.	قاعدة وحدة المعالجة المركزية
ايه إم دي AMD FCH A88X	مجموعة الشرائح
تدعم قناة مزدوجة دي. دي. ار. DDR3 800 / 1066 / 1333 / 1600 / 1866 / 2133 / 2400 (oc) 2600 (oc) 4x دي. دي. ار. DDR3 قحلت الذاكرة المزدوجة DIMM، تتحمل كحد أقصى 64 جيجابايت ذاكرة كل فتحة مزدوجة DIMM تتحمل دون 512 ECC ميجا بايت / 16/8/4/2/1 جيجابايت دي. دي. ار. DDR3 * يرجى الرجوع إلى الموقع www.biostar.com.tw لقائمة دعم الذاكرة.	الذاكرة
ايه إم دي AMD FCH A88X : وصلة x 8 ساتا SATA 6 جيجا بايت / الثانية تتحمل رايد RAID 10 / 5 / 1 / 0	التخزين
ريالتيك رت ل REALTEK RTL 8111 G 10 / 100 / 1000 ميجابايت / الثانية ، تحديد تلقائي ، النصف / القدرة القصوى المزدوجة	شبكة محلية LAN
ALC892 7.1 قنوات عالية الدقة، Biostar Hi-Fi 3D	الترميز الصوتي
منفذ x 4 نقل متسلسل عام USB 3.0 (2 في المداخل والمخرج الخلفية و 2 من خلال الموزع الداخلي) منفذ x 8 نقل متسلسل عام USB 2.0 (4 في المداخل والمخرج الخلفية و 4 من خلال الموزع الداخلي)	ناقل متسلسل عام USB
x 2 فتحة منفذ الملحقات الإضافية PCI x 2 فتحة منفذ الملحقات الإضافية PCIe 2.0 x 1 x 1 فتحة منفذ الملحقات الإضافية PCIe 3.0 x 16 (x16) x 1 فتحة منفذ الملحقات الإضافية PCIe 2.0 x 16 (x4)	فتحات التوسع
1 x 2 PS/2 لوحة المفاتيح للكمبيوتر/الفاة فتحة توصيل عدد 1 x HDMI وسيط متعدد العلي الوضوح فتحة توصيل عدد 1 x منظومة العرض المرئي VGA فتحة توصيل عدد 1 x واجهة مرئية رقمية DVI فتحة توصيل عدد 1 x الشبكة المحلية LAN فتحة توصيل عدد 4 x نقل متسلسل عام USB 2.0 فتحة توصيل عدد 2 x نقل متسلسل عام USB 3.0 فتحة توصيل عدد 6 x جاك للصوت	المداخل والمخارج الخلفية

Hi-Fi A88W 3D

المواصفات	
<p>وصلة 8 x SATA 6 جيجابايت / الثانية موزع 2 x نقل متسلسل عام USB 2.0 (كل موزع يتحمل قحتين نقل متسلسل عام USB 2.0) موزع 1 x نقل متسلسل عام USB 3.0 (كل موزع يتحمل قحتين نقل متسلسل عام USB 3.0) وصلة للطاقة 1 x 4 دبابيس وصلة للطاقة 1 x 24 دبوس وصلة 2 x مروحة تبريد وحدة المعالجة المركزية وصلة 3 x مراوح تبريد المنظومة موزع 1 x اللوحة الأممية موزع 1 x الصوت الأممي موزع 1 x سيهوس مباشر موزع 1 x مستهلك IR موزع 1 x قحة تسلسلية وصلة 1 x خارجية S/PDIF سوني فيليس الواجهة الرقمية</p>	<p>المدخل والمخرج الداخلية</p>
<p>عامل الشكل مدمج م 235 x 305 ، ATX ، ويندوز 7 / ويندوز 8</p>	<p>عامل الشكل</p>
<p>ويندوز إكس بي windows xp / ويندوز 7 / ويندوز 8 بيوستار BIOSTAR تحتفظ بحق إضافة أو إزالة الدعم لأي نظام تشغيل مع أو بدون أنظار.</p>	<p>أنظمة التشغيل المدعومة</p>

FRENCH

Spécifications	
Support Unité Centrale	Interface de connexion FM2+/FM2 pour série A AMD processeur Enveloppe thermique Unité Centrale maximum : 100Watt * Veuillez vous reporter à www.biostar.com.tw pour la liste des supports modèles d'Unité Centrale.
Jeu de puces	AMD A88X FCH
Mémoire	Supporte mémoire DDR3 double canal 800/ 1066/ 1333/ 1600/ 1866/ 2133/ 2400(OC)/ 2600(OC) Banc de mémoire 4 x DDR3 DIMM, Supporte max. jusqu'à une mémoire de 64 GB Chaque module DIMM supporte module DDR3 non-ECC 512MB/ 1/ 2/ 4/ 8/ 16 GB * Veuillez vous reporter à www.biostar.com.tw pour la liste des soutien de la mémoire.
Stockage	AMD A88X FCH Connecteur 8 x SATA 6Gb/s Supporte système RAID 0,1,10,5 & AHCI
Réseau local	Realtek RTL 8111G 10/ 100/ 1000 Mb/s auto négociation, capacité bidirectionnelle à l'alternat / bidirectionnelle simultanée
Codec audio	ALC892 Canaux 7.1, écoute audio de haute définition, Biostar Hi-Fi 3D
USB	Port 4x USB 3.0 (2 sur les I/O arrières et 2 en interne) Port 8x USB 2.0 (4 sur les I/O arrières et 4 en interne)
Connecteur d'extension	2x Fente PCI 2x PCIe 2.0 x1 Fente 1x PCIe 3.0 x16 Fente (x16) 1x PCIe 2.0 x16 Fente (x4)
I/O arrières	1x PS/2 Clavier/ Souris 1x Port HDMI 1x Port VGA 1x Port DVI 1x port LAN 4x Port USB 2.0 2x Port USB 3.0 6x entrées audio

Spécifications	
I/O en interne	<p>8x Connecteur SATA 6.0Gb/s</p> <p>2x embases USB 2.0 (chaque embase supporte 2 Ports USB 2.0)</p> <p>1x embase USB 3.0 (chaque embase supporte 2 Ports USB 3.0)</p> <p>1x 4-Broche de carte</p> <p>1x 24-Broche de carte</p> <p>2x Connecteur ventilateur unité centrale</p> <p>3x Connecteur ventilateur système</p> <p>1x Fiche panneau avant</p> <p>1x Fiche audio avant</p> <p>1x Fiche mémoire CMOS vide</p> <p>1x Fiche Registre d'état Consommateur</p> <p>1x Embase port série</p> <p>1x Connecteur sortie S/PDIF</p>
Facteur d'encombrement	Facteur d'encombrement ATX, 305mm x 235 mm
Support SE	<p>Windows XP / 7/ 8</p> <p>Biostar se réserve le droit d'ajouter ou d'enlever le support pour toute SE avec ou sans préavis.</p>

GERMAN

Spezifikationen	
CPU-Unterstützung	Anschluss-FM2+/FM2 für AMD A-Serie Prozessor Maximale CPU TDP (Thermal Design Power): 100 Watt * Bitte konsultieren Sie www.biostar.com.tw für CPU-Unterstützungsliste
Chipset	AMD A88X FCH
Festplattenspeicher	Unterstützt zweikanaliges DDR3 800/ 1066/ 1333/ 1600/ 1866/ 2133/ 2400(OC)/ 2600(OC) 4 x DDR3 DIMM-SpeicherSlot, Max. Unterstützung bis zu 64 GB-Speicher Jedes DIMM unterstützt nicht-ECC 512MB/ 1/ 2/ 4/ 8/ 16 GB DDR3-Module * Bitte konsultieren Sie www.biostar.com.tw für Speicherunterstützung Liste.
Arbeitsspeicher	AMD A88X FCH: 8x SATA 6Gb-Verbindung Unterstützt RAID 0,1,10,5 & AHCI
LAN	Realtek RTL 8111G 10/ 100/ 1000 Mb Auto-Negotiation, Halb- / Voll-Duplex-fähig
Audio-Codec	ALC892 7.1 Kanäle, HD-Audio, Biostar Hi-Fi 3D
USB	4x USB 3.0-Port (2 hintere I/Os und 2 via interne Header) 8x USB 2.0-Port (4 hintere I/Os und 4 via interne Header)
Erweiterungsanschlüsse	2x PCI-Slot 2x PCIe 2.0 x1-Slot 1x PCIe 3.0 x16-Slot (x16) 1x PCIe 2.0 x16-Slot (x4)
Hintere I/Os	1x PS/2-Keyboard/ Maus 1x HDMI-Port 1x VGA-Port 1x DVI-Port 1x LAN-Port 4x USB 2.0-Port 2x USB 3.0-Port 6x Audio Jack

Spezifikationen	
Interne I/Os	<p>8x SATA 6.0Gb/s-Verbindung</p> <p>2x USB 2.0-Header (jeder Header unterstützt 2 USB 2.0-Ports)</p> <p>1x USB 3.0-Header (jeder Header unterstützt 2 USB 3.0-Ports)</p> <p>1x 4-Pin-Stromverbindung</p> <p>1x 24-Pin-Stromverbindung</p> <p>2x CPU-Ventilatorverbindung</p> <p>3x System-Ventilatorverbindung</p> <p>1x Header für Frontpanel</p> <p>1x Header für Frontaudio</p> <p>1x Header für klares CMOS</p> <p>1x Consumer IR-Header</p> <p>1x Serieller Port-Header</p> <p>1x S/PDI-Auswurfsverbindung</p>
Formfaktor	ATX Formfaktor, 305mm x 235 mm
OS-Unterstützung	<p>Windows XP / 7/ 8</p> <p>Biostar reserves the right to add or remove support for any OS with or without notice.</p>

ITALIAN

Specificazioni	
Supporto processore	Slot FM2+/FM2 per processore AMD serie-A Alimentazione di Proiezione Termico (TDP – Thermal Design Power): 100Watt * Si prega di consultare www.biostar.com.tw per la lista di supporto del processore.
Tipo scheda	AMD A88X FCH
Memoria	Supporta DDR3 800/ 1066/ 1333/ 1600/ 1866/ 2133/ 2400(OC)/ 2600(OC) Doppio Canale 4 x DDR3 DIMM Slot di Memoria Supporta fino a 64 GB Memoria Ogni DIMM supporta non-ECC 512MB/ 1/ 2/ 4/ 8/ 16 GB DDR3 moduli * Si prega di consultare www.biostar.com.tw per la lista di supporto del memoria.
Memorizzazione	AMD A88X FCH: Connettore 8x SATA 6Gb/s Supporta RAID 0,1,10,5 & AHCI
Catena	Realtek RTL 8111G 10/ 100/ 1000 Mb auto negoziazione, capacita di duplex Meta / Completo
Codec Audio	ALC892 Canali Audio di Alta Definizione 7.1, Biostar Hi-Fi 3D
USB	Slot 4x USB 3.0 (2 nei ingressi/ uscite posteriore e 2 da distributori interni) Slot 8x USB 2.0 (4 nei ingressi/ uscite posteriore e 4 da distributori interni)
Slot di espansione	Slot 2x PCI Slot 2x PCIe 2.0 x1 Slot 1x PCIe 3.0 x16 (x16) Slot 1x PCIe 2.0 x16 (x4)
Ingressi/ Uscite Posteriore	Tastiera/ Mouse 1x PS/2 Slot 1x HDMI Slot 1x VGA Slot 1x DVI Slot 1x LAN Slot 4x USB 2.0 Slot 2x USB 3.0 Jack audio 6x

Specificazioni	
Ingressi/ Uscite Interni	Connettore 8x SATA 6.0Gb/s Distributore 2x USB 2.0(ogni distributore supporta 2 slot USB 2.0) Distributore 1x USB 3.0(ogni distributore supporta 2 slot USB 3.0) Connettore con 4 pin x1 Connettore con 24 pin x1 Connettore Ventilatore processore x2 Connettore Ventilatore Sistema x3 Distributore Pannello Frontale x1 Distributore Audio Frontale x1 Distributore CMOS Diretto x1 Distributore Consumabile IR x1 Distributore Slot Serie x1 Connettore esterno S/PDIF x1
Fattore di Forma	Fattore di Forma ATX, 305mm x 235 mm
Supporto SO	Windows XP / 7/ 8 Biostar si riserva il diritto di aggiungere o ritirare il supporto per qualsiasi SO con o senza preavviso.

JAPANESE

仕様	
CPU サポート	AMD A-シリーズ プロセッサの Socket FM2+/FM2 最大 CPU TDP (Thermal Design Power 最大放熱量) :100 W *CPU サポート リストについては、 www.biostar.com.tw を参照してください。
チップセット	AMD A88X FCH
メモリ	デュアルチャンネル DDR3 800/ 1066/ 1333/ 1600/ 1866/ 2133/ 2400(OC)/ 2600(OC) をサポート 4 x DDR3 DIMM メモリ スロット、最大 64 GB メモリまでサポート 各 DIMM は、非-ECC 512MB/ 1/ 2/ 4/ 8/ 16 GB DDR3 モジュールをサポートしています *サポートされているメモリのリストについては、 www.biostar.com.tw を参照してください。
保存スペース	AMD A88X FCH: 8x SATA 6Gb/s コネクタ RAID 0,1,10,5 & AHCI のサポート
LAN	Realtek RTL 8111G 10/ 100/ 1000 Mb/s オートネゴシエーション、半/全 二重通信
オーディオ コーデック	ALC892 7.1 チャンネル、ハイ デフィニション オーディオ、Biostar Hi-Fi 3D
USB	4x USB 3.0 ポート (後部 I/O に2つ 及び 内蔵 ヘッダー経由に2つ) 8x USB 2.0 ポート (後部 I/O に4つ 及び 内蔵ヘッダー経由に4つ)
拡張スロット	2x PCI スロット 2x PCIe 2.0 x1 スロット 1x PCIe 3.0 x16 スロット(x16) 1x PCIe 2.0 x16 スロット(x4)
後部 I/O	1x PS/2 キーボード/マウス 1x HDMI ポート 1x VGA ポート 1x DVI ポート 1x LAN ポート 4x USB 2.0 ポート 2x USB 3.0 ポート 6x オーディオ ジャック

仕様	
内蔵 I/O	8x SATA 6.0Gb/s コネクタ 2x USB 2.0 ヘッダー (各ヘッダーは、2つの USB 2.0 ポートをサポートしています) 1x USB 3.0 ヘッダー (各ヘッダーは、2つの USB 3.0 ポートをサポートしています) 1x 4-Pin パワー コネクタ 1x 24-Pin パワー コネクタ 2x CPU ファン コネクタ 3x システム ファン コネクタ 1x フロント パネル ヘッダー 1x フロント オーディオ ヘッダー 1x クリア CMOS ヘッダー 1x コンシューマー IR ヘッダー 1x シリアル ポート ヘッダー 1x S/PDIF アウト コネクタ
フォーム ファクタ	ATX フォーム ファクタ、305mm x 235 mm
サポート OS	Windows XP / 7/ 8 Biostar には、通知なしでサポート OS を変更する権限があります。

POLISH

Specyfikacje techniczne	
Obsługa procesora	Gniazdo procesora (Socket) FM2+/FM2 dla procesorów AMD seria-A Moc Wydzielanego Ciepła (TDP - Thermal Design Power): 100Watt * Proszę sprawdzić listę obsługiwanych procesorów na stronie internetowej www.biostar.com.tw
Rodzaj płyty	AMD A88X FCH
Pamięć	Obsługa pamięci DDR3 800/ 1066/ 1333/ 1600/ 1866/ 2133/ 2400(OC)/ 2600(OC) Dwukanałowa 4 x DDR3 DIMM Pamięć Gniazda procesora (Slot), Maksymalna wielkość pamięci 64 GB Każdy DIMM obsługuje jeden moduł non-ECC 512MB/ 1/ 2/ 4/ 8/ 16 GB DDR3 * Proszę sprawdzić listę obsługiwanych pamięć na stronie internetowej www.biostar.com.tw
Przechowywanie	AMD A88X FCH: Złącze 8x SATA 6Gb/s Obsługa RAID 0,1,10,5 & AHCI
LAN	Układ RTL 8111G 10/ 100/ 1000 Mb auto negocjacja, pojemność duplex Połowe / Pełny
Codec Audio	ALC892 Kanały Audio wysokiej Definicji 7.1, Biostar Hi-Fi 3D
USB	4 x złącza USB 3.0 (2 przez tylne porty wejścia/ wyjścia oraz 2 przez wewnętrzne porty) 8 x złącza USB 2.0 (4 przez tylne porty wejścia/ wyjścia oraz 4 przez wewnętrzne porty)
Złącza rozszerzeń	złącza 2x PCI (Slot) złącze 2x PCIe 2.0 x1 (Slot) złącza 1x PCIe 3.0 x16 (Slot) (x16) złącza 1x PCIe 2.0 x16 (Slot) (x4)
Tylne porty wejścia/ wyjścia	Klawiatura/ Myszka 1x PS/2 Port 1x HDMI (gniazdo) Port 1x VGA Port 1x DVI Port 1x LAN Porty 4x USB 2.0 Porty 2x USB 3.0 Porty audio 6x

Specyfikacje techniczne	
Wewnętrzne porty wejścia/ wyjścia	<p>Złącza 8x SATA 6.0Gb/s</p> <p>Złącza 2x USB 2.0 (każde złącze obsługuje dodatkowe 2 porty USB 2.0)</p> <p>Złącze 1x USB 3.0 (każde złącze obsługuje dodatkowe 2 porty USB 3.0)</p> <p>Złącza 4 pionowe x 1</p> <p>Złącza 24 pionowe x 1</p> <p>Złącze wentylatora CPU x 2</p> <p>Złącze wentylatora obudowy x 3</p> <p>Złącze przedniego panelu x1</p> <p>Złącze audio przedniego panelu x1</p> <p>Złącze bezpośrednie CMOS x1</p> <p>Złącze konsument IR x1</p> <p>Port szeregowy x1</p> <p>Port zewnętrzny S/PDIF x1</p>
Obudowa	Obudowa ATX, 305mm x 235 mm
Obsługa OS	<p>Windows XP / 7/ 8</p> <p>Biostar zastrzega sobie prawo do dodania lub wycofania obsługi dla OS, z wypowiedzeniem lub bez wypowiedzenia.</p>

PORTUGUESE

Especificações	
Suporte Processador	Porta FM2+/FM2 para processador AMD série-A Alimentação de Design Térmico (TDP – Thermal Design Power): 100Watt * Por favor consulte www.biostar.com.tw para obter uma lista de suporte do processador.
Tipo Placa Mãe	AMD A88X FCH
Memória	Suporta DDR3 800/ 1066/ 1333/ 1600/ 1866/ 2133/ 2400(OC)/ 2600(OC) Canal Duplo 2 x DDR3 DIMM Slot de memória Suporta até 32 GB Memória Cada DIMM suporta non-ECC 512MB/ 1/ 2/ 4/ 8/ 16 GB DDR3 módulo * Por favor consulte www.biostar.com.tw para obter uma lista de suporte do memória.
Armazenamento	AMD A88X FCH: Conector 8x SATA 6Gb/s Suporta RAID 0,1,10,5 & AHCI
LAN	Realtek RTL 8111G 10/ 100/ 1000 Mb auto negociação, capacidade duplex Metade / Cheio
Codec de Audio	ALC892 Canais de Áudio de Alta Definição 7.1, Biostar Hi-Fi 3D
USB	Porta 4x USB 3.0 (2 nas entradas/saídas traseiras e 2 pelos Dispositivos internos) Porta 8x USB 2.0 (4 nas entradas/saídas traseiras e 4 pelos Dispositivos internos)
Slots de expansão	Porta 2x PCI Porta 2x PCIe 2.0 x1 Porta 1x PCIe 3.0 x16 (x16) Porta 1x PCIe 2.0 x16 (x4)
Entradas/Saídas no painel traseiro	Teclado/ Mouse 1x PS/2 Porta 1x HDMI Porta 1x VGA Porta 1x DVI Porta 1x LAN Porta 4x USB 2.0 Porta 2x USB 3.0 Soquete audio 6x

Especificações	
Conectores na placa	<p>Conector 8x SATA 6.0Gb/s</p> <p>Dispositivo 2x USB 2.0 (cada Dispositivo suporta 2 portas USB 2.0)</p> <p>Dispositivo 1x USB 3.0 (cada Dispositivo suporta 2 portas USB 3.0)</p> <p>Conector de 4 pinos x1</p> <p>Conector de 24 pinos x1</p> <p>Conector de Ventoinha processador x2</p> <p>Conector de Ventoinha Sistema x3</p> <p>Dispositivo Painel Frontal x1</p> <p>Dispositivo de Audio Frontal x1</p> <p>Dispositivo CMOS Direct x1</p> <p>Dispositivo Consumível IR x1</p> <p>Dispositivo Porta Impressora x1</p> <p>Dispositivo Porta Série x1</p> <p>Conector Externo S/PDIF x1</p>
Fator de Fôrma	Fator de Fôrma ATX, 305mm x 235 mm
Suporte OS	<p>Windows XP / 7/ 8</p> <p>BioStar reserva seu direito de adicionar ou retirar o suporte para qualquer OS com ou sem notificação.</p>

RUSSIAN

Спецификации	
Поддержка центрального процессора	Сокет FM2+/FM2 для процессоров AMD серии A Максимальный термopakет центрального процессора (TDP): 100 ватт * Перечень поддержки центрального процессора смотрите на www.biostar.com.tw .
Набор микросхем	AMD A88X FCH
Память	Поддерживает двухканальный DDR3 800/ 1066/ 1333/ 1600/ 1866/ 2133/ 2400(OC)/ 2600(OC) 4 гнезда платы памяти DDR3 DIMM, максимальная память до 64 Гб Каждый модуль DIMM поддерживает модуль не-ECC 512 Мб/ 1/ 2/ 4/ 8/ 16 Гб DDR3 * Перечень поддержки памяти смотрите на www.biostar.com.tw .
Накопитель	AMD A88X FCH: Соединитель 8x SATA 6 Гб/с Поддерживает RAID 0,1,10,5 & AHCI
Локальная сеть	Realtek RTL 8111G Автосогласование 10/ 100/ 1000 Мб/с, работает в полно/полудуплексном режиме
Аудиокодек	ALC892 Каналы 7.1, высококачественное аудио, Biostar Hi-Fi 3D
USB	4 порта USB 3.0 (2 сзади ввода-вывода и 2 через внутренние контакты) 8 порта USB 2.0 (4 сзади ввода-вывода и 4 через внутренние контакты)
Гнезда расшир.	2x гнезда PCI 2x PCIe 2.0 x1 гнездо 1x PCIe 3.0 x16 гнездо (x16) 1x PCIe 2.0 x16 гнездо (x4)
Задняя плата ввода-вывода	1 клавиатура/ мышь PS/2 1 порт HDMI 1 порт VGA 1 порт DVI 1 порт локальной сети 4 порта USB 2.0 2 порта USB 3.0 6 гнезд для подключения наушников

Спецификации	
Внутр. Плата ввода-вывода	<p>Соединитель 8x SATA 6 Гб/с</p> <p>2 контакта USB 2.0 (каждый контакт поддерживает 2 порта USB 2.0)</p> <p>1 контакт USB 3.0 (каждый контакт поддерживает 2 порта USB 3.0)</p> <p>1 4-выводный разъем питания</p> <p>1 24-выводный разъем питания</p> <p>2 разъем вентилятора ЦП</p> <p>3 разъема вентилятора системы</p> <p>1 контакт передней панели</p> <p>1 контакт передней аудиопанели</p> <p>1 контакт микросхемы Clear CMOS</p> <p>1 инфракрасный пользовательский контакт</p> <p>1 контакт последовательного порта</p> <p>1 соединитель S/PDIF-Out</p>
Конструктив	Форм-фактор ATX, 305мм x 235 мм
Поддержка ОС	<p>Windows XP / 7/ 8</p> <p>Biostar оставляет за собой право добавлять или удалять поддержку любой ОС, с уведомлением или без.</p>

SPANISH

Especificaciones	
Compatibilidad con el procesador	Ranura FM2+/FM2 para procesador AMD serie - A Alimentación de Proyección Térmica (TDP – Thermal Design Power): 100Watt *Por favor consultar con www.biostar.com.tw para la lista de compatibilidad con el procesador.
Tipo de Placa	AMD A88X FCH
Memoria	Soporta DDR3 800/ 1066/ 1333/ 1600/ 1866/ 2133/ 2400(OC)/ 2600(OC) Doble Canal 4x DDR3 DIMM Ranura de memoria Soporta hasta 64 GB Memoria Cada DIMM soporta un modulo non-ECC 512MB/ 1/ 2/ 4/ 8/ 16 GB DDR3 *Por favor consultar con www.biostar.com.tw para la lista de compatibilidad con el memoria.
Almacenamiento de información	AMD A88X FCH: Conector 8x SATA 6Gb/s Soporta RAID 0,1,10,5 & AHCI
LAN	Realtek RTL 8111G 10/ 100/ 1000 Mb/s auto negociación, capacidad dúplex Mitad/Completo
Códec Audio	ALC892 Canales Audio de Alta Definición 7.1, Biostar Hi-Fi 3D
USB	Ranura 4x USB 3.0 (2 en las entrada/salidas posteriores y 2 por los distribuidores internos) Ranura 8x USB 2.0 (4 en las entrada/salidas posteriores y 4 por los distribuidores internos)
Ranuras de Extinción	Ranura 2x PCI Ranura 2x PCIe 2.0 x1 Ranura 1x PCIe 3.0 x16 (x16) Ranura 1x PCIe 2.0 x16 (x4)
Panel trasero de E/S	Teclado/ Ratón 1x PS/2 Ranura 1x HDMI Ranura 1x VGA Ranura 1x DVI Ranura 1x LAN Ranura 4x USB 2.0 Ranura 2x USB 3.0 Socket audio 6x

Especificaciones	
Conectores en placa	<p>Conector 8x SATA 6Gb/s</p> <p>Distribuidor 2x USB 2.0 (cada distribuidor soporta 2 ranuras USB 2.0)</p> <p>Distribuidor 1x USB 3.0 (cada distribuidor soporta 2 ranuras USB 3.0)</p> <p>Conector con 4 patillas x1</p> <p>Conector con 24 patillas x1</p> <p>Conector Ventilador procesador x2</p> <p>Conector Ventilador Sistema x3</p> <p>Distribuidor Panel Frontal x1</p> <p>Distribuidor Audio Frontal x1</p> <p>Distribuidor CMOS Directo x1</p> <p>Distribuidor Consumible IR x1</p> <p>Distribuidor Ranura Serie x1</p> <p>Conector Externo S/PDIF x1</p>
Factor de Forma	Factor de Forma ATX, 305mm x 235 mm
Soporte OS	<p>Windows XP / 7/ 8</p> <p>BioStar reserva su derecho de añadir o retirar el soporte para cada OS con o sin notificación.</p>

2013/08/27